

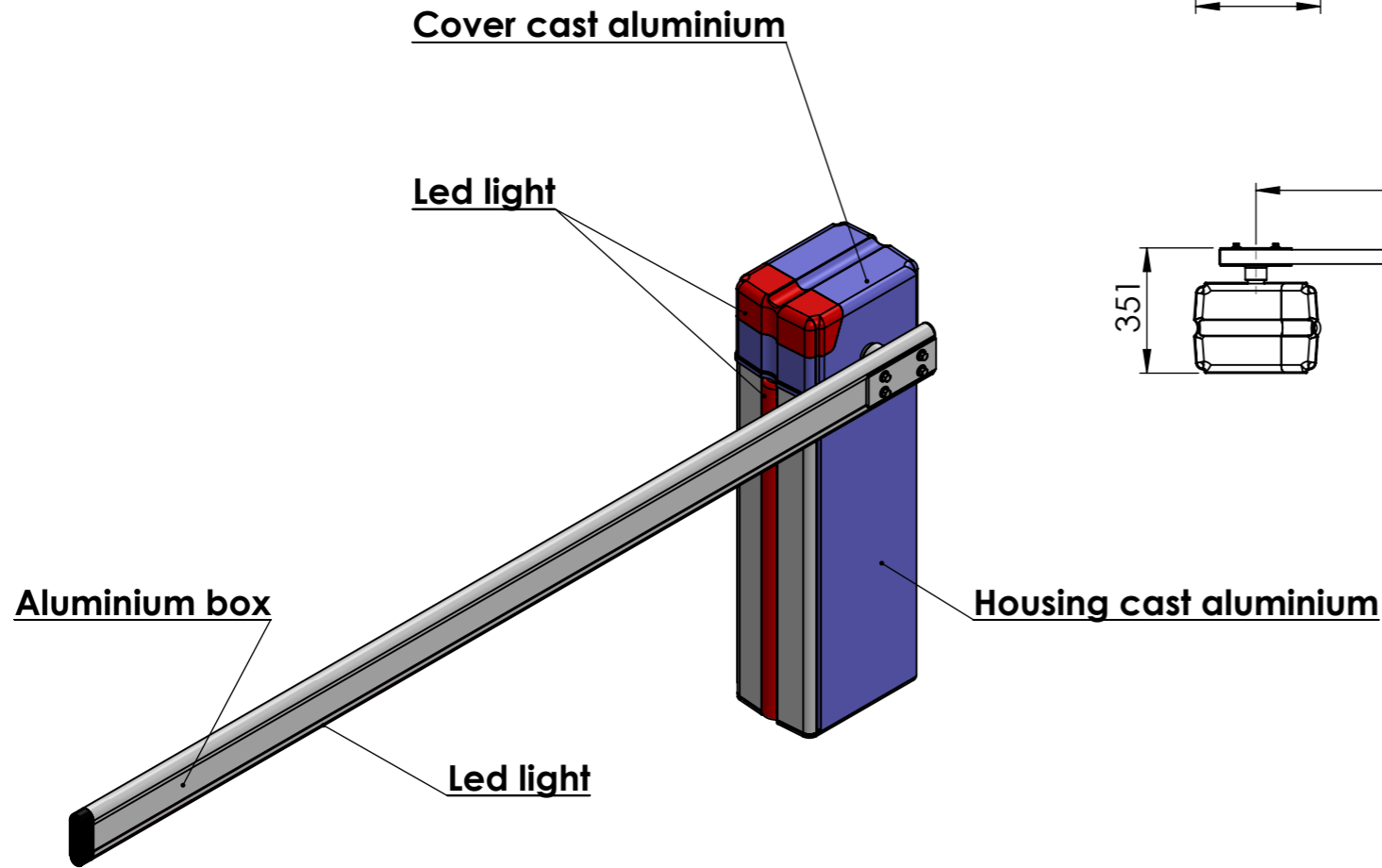

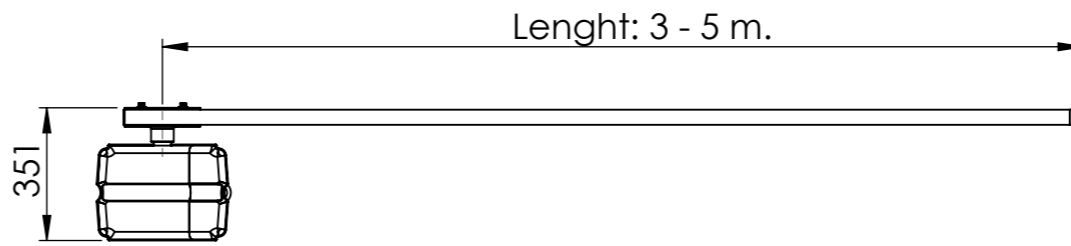

LIFT ARM BARRIER ITEM: L1050

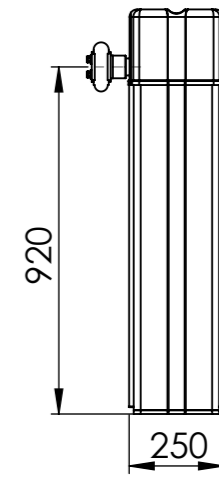
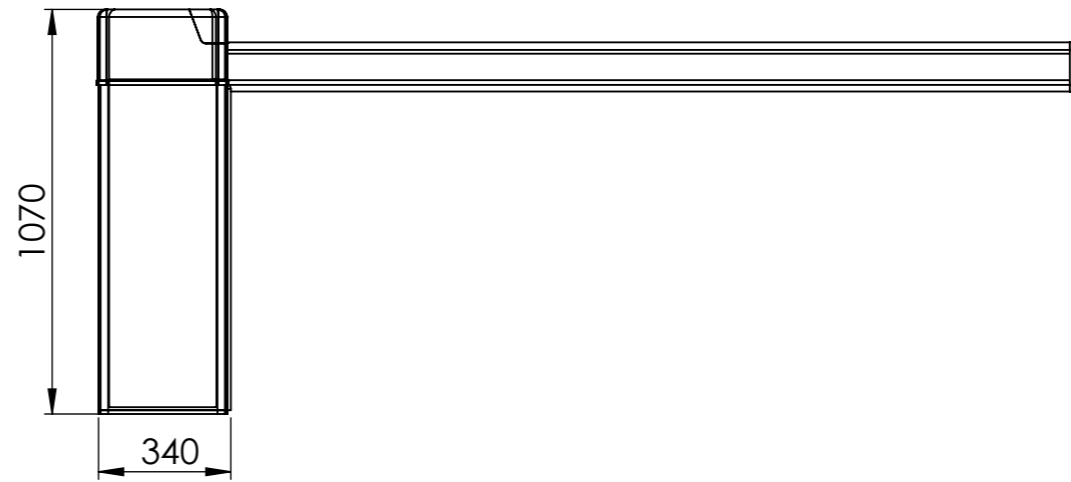

UNLESS OTHERWISE SPECIFIED: DIMENSIONS ARE IN MILLIMETERS SURFACE FINISH: TOLERANCES: ±0.1 mm. LINEAR: ±0.5 mm. ANGULAR: ±0.5°		FINISH:	Quant.	DO NOT SCALE DRAWING	REVISION
DRAWN		NAME	SIGNATURE	DATE	Project: LIFT ARM BARRIER ITEM: L1050 B.G.Ilanit Gates & Urban elements LTD. Site: www.bgibarriers.com Phone: 972-3-5500465 Fax: 972-3-5583113 E-mail: info@bgilanit.com  BGI INTELLIGENT BARRIER SOLUTIONS
CHK'D					
APPV'D					
MFG					
Q.A					
		MATERIAL:		DWG NO.	A3
		WEIGHT:		SCALE:1:50	SHEET 1 OF 2

Barrier type: **Light arm barrier**
 Mechanism: **Electric with emergency manual control**
 Power supply: **240VAC**
 Safety: **Infrared sensor. Warning light and/or traffic light.**

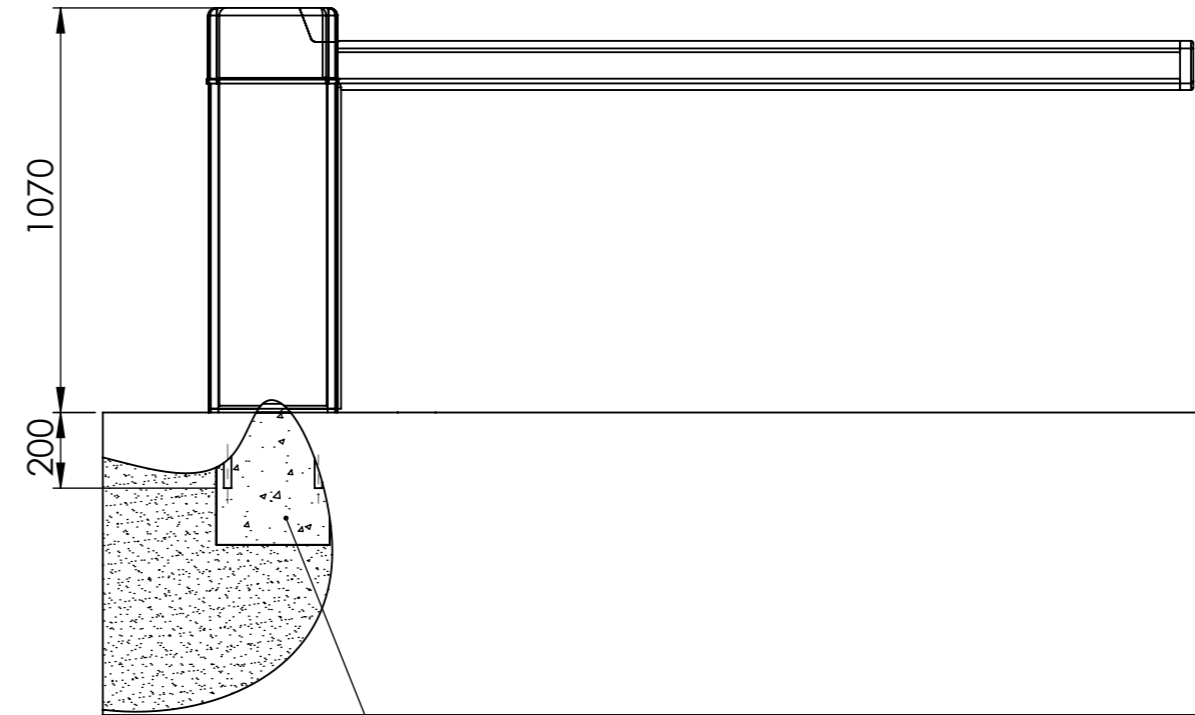
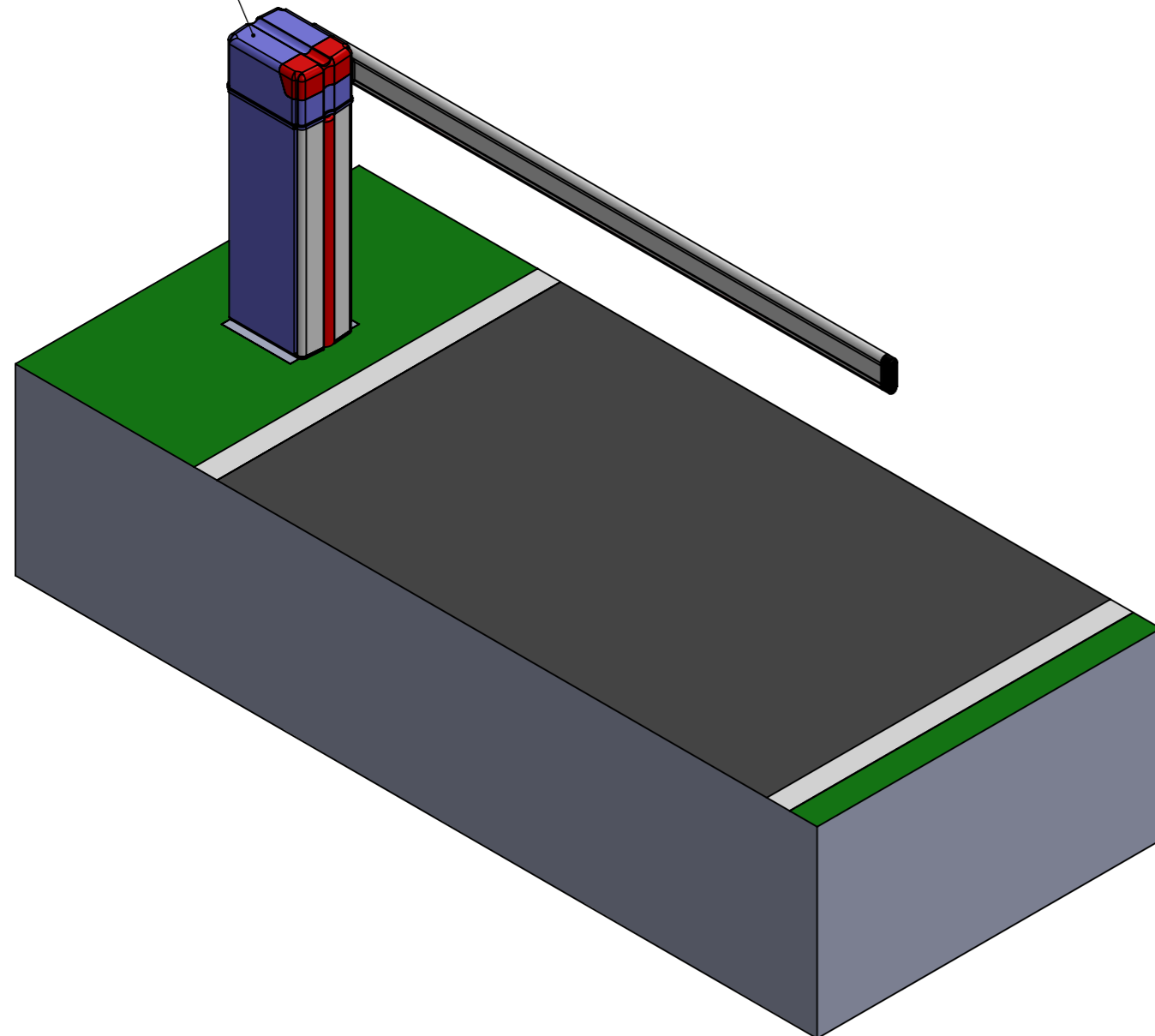

Concrete

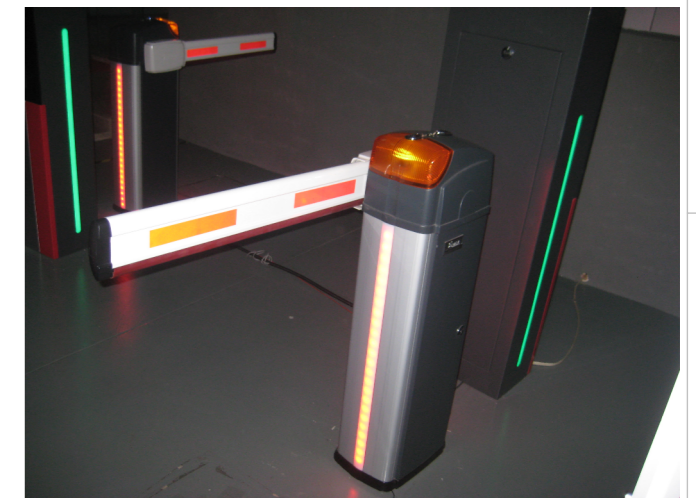

UNLESS OTHERWISE SPECIFIED: DIMENSIONS ARE IN MILLIMETERS		FINISH:	Quant.	DO NOT SCALE DRAWING	REVISION
SURFACE FINISH:				Project:	
TOLERANCES: ±0.1 mm.				LIFT ARM BARRIER ITEM: L1050	
LINEAR: ±0.5 mm.				B.G.Ilanit Gates & Urban elements LTD.	
ANGULAR: ±0.5°				Site: www.bgibarriers.com	
NAME	SIGNATURE	DATE		Phone: 972-3-5500465	
DRAWN				Fax: 972-3-5583113	
CHK'D				E-mail: info@bgilanit.com	
APPV'D				BGI INTELLIGENT BARRIER SOLUTIONS	
MFG				DWG NO.	A3
Q.A			MATERIAL:	L1050-B.G.Ilanit	
			WEIGHT:	SCALE:1:50	SHEET 2 OF 2